



**ResMed**

ClimateLineAir™  
ClimateLineAir Oxy

ResMed

ClimateLineAir™ | ClimateLineAir Oxy



User guide

User guide

English | Deutsch | Français | Italiano | Español | Português  
Nederlands | Svenska | Norsk | Dansk | Suomi  
Eesti | Český | 简体中文 | 繁體中文 | العربية

ENGLISH

### About your ClimateLineAir

The ClimateLineAir™ is heated air tubing that delivers the desired temperature at your mask. ClimateLineAir Oxy is a variant of the ClimateLineAir that has a built-in oxygen connector to attach a supplemental oxygen supply.

When used with the HumidAir™ humidifier, ClimateLineAir heated air tubing allows you to use Climate Control. Climate Control is designed to make therapy more comfortable by enabling constant temperature and maintaining humidity.

The ClimateLineAir heated air tubing is designed for use with AirSense™ 10 / AirCurve™ 10 and Lumis™ devices. Please read this entire user guide together with your device user guide before using your ClimateLineAir heated air tubing.

**Note:**

- Not all types of air tubing are available in all regions.
- Lumis does not include S9 Lumis Tx.

### Setup

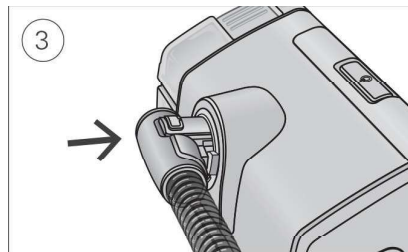
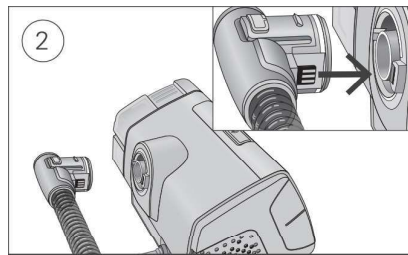
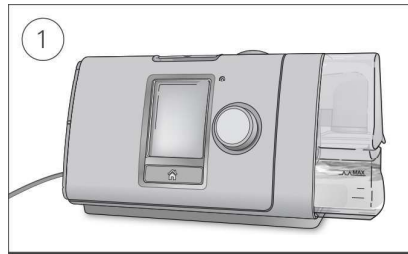

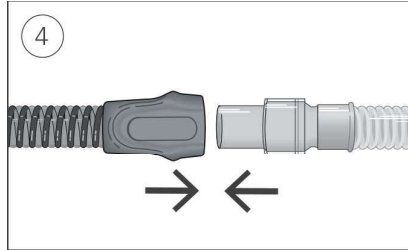

1. Make sure the device is connected and turned on.
2. Hold the cuff of the air tubing and line up the air tubing connector with the connector port.
3. Push the cuff until the connector clicks into place.  
**ClimateLineAir connected** will briefly display on the device screen.
4. Connect the assembled mask to the free end of the air tubing.

### Setup with supplemental oxygen

To set up the ClimateLineAir Oxy with supplemental oxygen, perform the steps outlined in the setup section and the following additional steps.

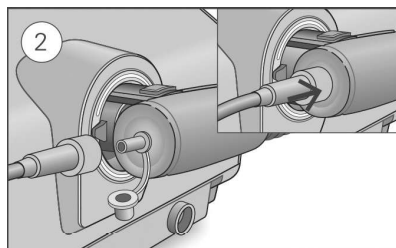
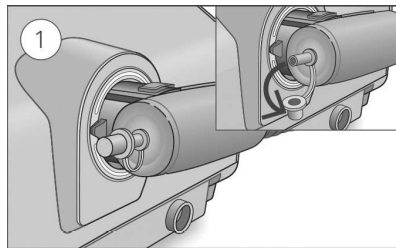

1. Remove the cap from the oxygen connector.
2. Connect the oxygen supply tubing to the oxygen connector.  
Make sure it is firmly attached.

**Notes:**

- Before adding oxygen, familiarize yourself with the specific warnings relating to the use of supplemental oxygen. These can be found at the end of your device User Guide.
- If you use the ClimateLineAir Oxy without supplemental oxygen, make sure the cap of the oxygen connector is firmly attached.

## Climate Control

Climate Control is an intelligent system that controls the humidifier and the ClimateLineAir heated air tubing to deliver constant, comfortable temperature and humidity levels during therapy.

Designed to prevent dryness of the nose and mouth, it maintains the set temperature and relative humidity while you sleep. Climate Control can be set to either Auto or Manual and is only available when both the ClimateLineAir and the HumidAir humidifier are attached.

### Climate Control Auto

Climate Control Auto is the recommended and default setting. Climate Control Auto is designed to make therapy as easy as possible, so there is no need to change the temperature or humidity settings.

The Tube Temperature is set to Auto (80°F [27°C]) and Climate Control adjusts the humidifier output to maintain a constant, comfortable humidity level of 85% relative humidity while protecting against rainout (water droplets in the air tubing and mask).

### Tube Temperature

In Climate Control Auto there is no need to change any settings, but if the air in the mask feels too warm or cold you can adjust the tube temperature to find what is most comfortable for you. You can set the Tube Temperature to anywhere between 60–86°F (16–30°C), or turn it off completely.

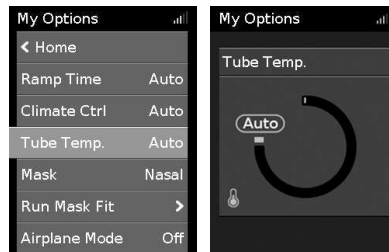

### To adjust the Tube Temperature:

1. In **My Options**, turn the dial to highlight **Tube Temperature** and then press the dial.
2. Turn the dial to adjust the temperature and press the dial to save the change.

## Climate Control Manual

Designed to offer you more flexibility and control over your settings, Climate Control Manual lets you adjust the temperature and humidity to the setting which is most comfortable for you.

In Climate Control Manual, the tube temperature and the humidity level can be set independently however, rainout protection is not guaranteed. If rainout does occur, first try increasing the tube temperature. If the air temperature becomes too warm and rainout continues, try decreasing the humidity.

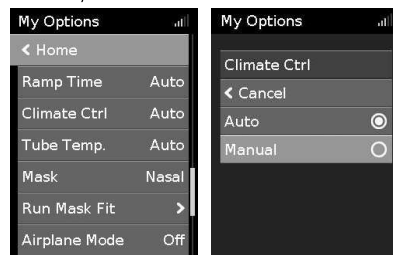

### To change to Climate Control Manual:

1. In **My Options**, turn the dial to highlight **Climate Ctrl** and then press the dial.
2. Turn the dial to select **Manual** and press the dial to save the change.

### Humidity Level

The humidifier moistens the air and is designed to make therapy more comfortable. If you are getting a dry nose or mouth, turn up the humidity. If you are getting any moisture in your mask, turn down the humidity.

You can set the Humidity Level to Off or between 1 and 8, where 1 is the lowest humidity setting and 8 is the highest humidity setting.

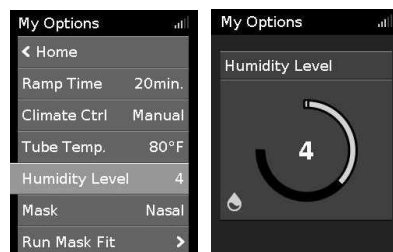

### To adjust the Humidity Level:

1. In **My Options**, turn the dial to highlight **Humidity Level** and then press the dial.
2. Turn the dial to adjust the humidity level and press the dial to save the change.

If you have been using Climate Control Manual and want to return to Climate Control Auto, follow the instructions below.

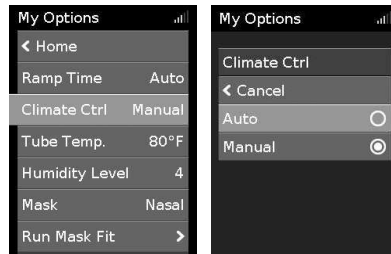

#### To change to Climate Control Auto:

1. In **My Options**, turn the dial to highlight **Climate Ctrl** and then press the dial.
2. Turn the dial to select **Auto** and then press the dial to save the change.

It is important that you regularly clean your air tubing to make sure you receive optimal therapy. The following sections will help you with disconnecting, cleaning, checking and reconnecting your air tubing.

#### Disconnecting

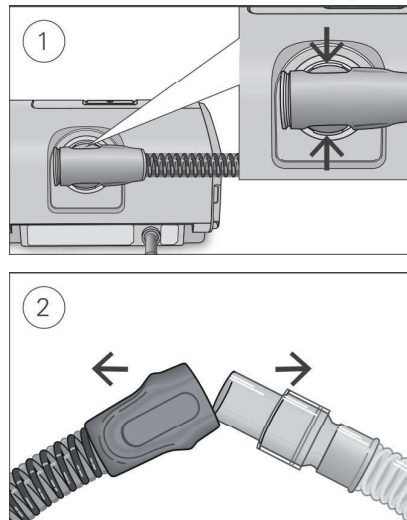

1. Hold the cuff of the air tubing, apply gentle pressure to the release buttons and pull it away from the device.
2. Hold both the cuff of the air tubing and the swivel of the mask, then gently pull apart.

**Note:** Only hold and pull the cuff of the air tubing. Do not hold or pull the tubing itself as it may cause damage.

## Cleaning

You should clean the air tubing weekly as described.

1. Wash the air tubing in warm water using mild detergent. Do not wash in a dishwasher or washing machine.
2. Rinse the air tubing thoroughly and allow to dry, out of direct sunlight and/or heat.

## Checking

You should regularly check the air tubing for any damage. If there are any holes, tears or cracks you should replace it.

## Reconnecting the air tubing

When the air tubing is dry, you can reconnect it to the device.

1. Connect the air tubing firmly to the air outlet located on the rear of the device.
2. Connect the free end of the air tubing firmly onto the assembled mask.

## Troubleshooting

If you have any problems, refer to the troubleshooting section of your device user guide or [www.resmed.com](http://www.resmed.com).

**Note:** For any serious incidents that occur in relation to this device, these should be reported to ResMed and the competent authority in your country.

## Technical specifications

### Environmental conditions

Operating temperature:	+41°F to +95°F (+5°C to +35°C) <b>Note:</b> The air flow for breathing produced by this therapy device can be higher than the temperature of the room. Under extreme ambient temperature conditions (104°F/40°C) the device remains safe.
Operating humidity:	10 to 95% relative humidity, non-condensing
Operating altitude:	Sea level to 8,500' (2,591 m); air pressure range 1013 hPa to 738 hPa
Storage and transport temperature:	-4°F to +140°F (-20°C to +60°C)
Storage and transport humidity:	5 to 95% relative humidity, non-condensing

### Electromagnetic compatibility / Air tubing resistance to flow and compliance values

Refer to the device User Guide.

### Temperature

Temperature range:	+60 to +86°F (+16 to +30°C)
Cut-out:	+106°F (+41°C)

### Operating pressure range

Maximum recommended pressure	30 cm H <sub>2</sub> O (30 hPa)
------------------------------	---------------------------------

## Physical

Air tubing	Material	Length	Inner diameter
ClimateLineAir	Flexible plastic and electrical components	6'6" (2 m)	0.6" (15 mm)
ClimateLineAir Oxy	Flexible plastic and electrical components	6'4" (1.9 m)	0.75" (19 mm)

## Design life

Air tubing: Standard, SlimLine, ClimateLineAir, ClimateLineAir Oxy 6 months



## Symbols

The following symbols may appear on the product or packaging.

 Manufacturer.  European Authorized Representative.  Catalog number.  Batch code.

**Rx Only** Prescription only (In the US, Federal law restricts these devices to sale by or on the order of a physician).

 Humidity limitation.  Temperature limitation.

 Atmospheric pressure limitation.  China pollution control logo 1.  China pollution control logo 2.

 Importer.  Medical device.

See symbols glossary at [ResMed.com/symbols](https://www.resmed.com/symbols).



## Environmental information

This device should be disposed of separately, not as unsorted municipal waste. To dispose of your device, you should use appropriate collection, reuse and recycling systems available in your region. The use of these collection, reuse and recycling systems is designed to reduce pressure on natural resources and prevent hazardous substances from damaging the environment.

If you need information on these disposal systems, please contact your local waste administration. The crossed-bin symbol invites you to use these disposal systems. If you require information on collection and disposal of your ResMed device please contact your ResMed office, local distributor or go to [www.resmed.com/environment](https://www.resmed.com/environment).

## Limited warranty

Refer to your device user guide.



 **ResMed Pty Ltd**  
1 Elizabeth Macarthur Drive  
**MANUFACTURER** Bella Vista NSW 2153 Australia

See ResMed.com for other ResMed locations worldwide. AirSense, AirCurve, ClimateLine, HumidAir and Lumis are trademarks and/or registered trademarks of the ResMed family of companies. For patent and other intellectual property information, see ResMed.com/ip  
© 2019 ResMed Pty Ltd. 378461/1 2019-08

**ResMed.com**

 0123



378461